



PARTS: (561) 253-3311

888-538-1000
TEL (561) 588-5200
FAX (561) 493-2999
PARTS FAX (561) 493-2990
SERVICE: (561) 253-3310

51 Hypoluxo Rd.
Hypoluxo, FL 33462-4501
www.benchmarkgames.com

TICKET STATION



PLEASE READ FIRST BEFORE
PLUGGING IN MACHINE

ALL RIGHT RESERVED. PAT. PENDING

54MAN-01-C



Table of Contents

General Operation	2
Air Blast Cleaning System	3
Setup	4
Changing Ticket Bags	5
Loading Printer Paper	6
Tower Light Status	7
Ticket Taker General	7-9
Ticket Taker Overview	7-8
Ticket Taker Operation	9
Clearing a Ticket Jam	9
Troubleshooting Guide	10-13
Programming	14
Error Codes	16
Parts List	17-18
Schematics	19-20

Built for Reliability

The Benchmark Ticket Station is a compact ticket cash in machine that was engineered for reliability. Here are some of the key features you should be aware of:

1. Self Cleaning

- All of the opto sensors and barcode scanners are automatically cleaned with an air blast regularly

2. Independent Systems

- Each door contains a ticket taker system independent from one another. If there is a problem with one of the systems, the remaining systems will still operate

3. Redundant Power Supplies

- There are two power supplies in each ticket station.

4. Status Tower Light

- The ticket station features a tower light that will signal a printer problem (out of paper etc.), a ticket taker problem, and will let you know when the ticket bags are full

5. Low Dust Cutting

- The cutters in the Ticket Station are designed to cut the tickets like a pair of scissors for low dust creation, contributing to clean optos and barcode scanners.

1 to 4 Stations Field Expandable

Standard unit is complete and ready to add another station at any time. Just bolt the door on and plug it in.

Important Note:

Each of the access doors uses a power lockout switch. When the door is open, the ticket taker will not operate unless you manually pull the switch to turn it on. If you must activate the power while the door is open, use caution around the moving parts and belts in the ticket taker.

For more information and service details, please visit www.benchmarkgames.com.

Setup

1. Install Power Cord

The power cord can be run down and out the bottom of the machine or up and out the top of the machine.

- To run the cord out the bottom of the machine:
 1. Feed the power cord① through the lower power cord hole② in the bottom of the machine.
 2. Connect power cord to the power connector③ at the main harness.
-Be sure to secure the wires tight along the inside corner away from the scale floor④
 3. Plug power cord into a power receptacle. If a floor receptacle is used, position machine over the top of it.
- To run the cord up and out the top of the machine:
 1. Detach the power wires⑤ from the wire clips on the inside left corner of machine
 2. Run power wires up inside corner attaching into wire clips
 3. Remove wire plate screws⑥ and wire plate⑦
 4. Connect power cord to power connector⑧ on the main harness.
 5. Run the power cord up and out the top of the machine securing with wire clips.
 6. Replace wire plate and reattach with screws.

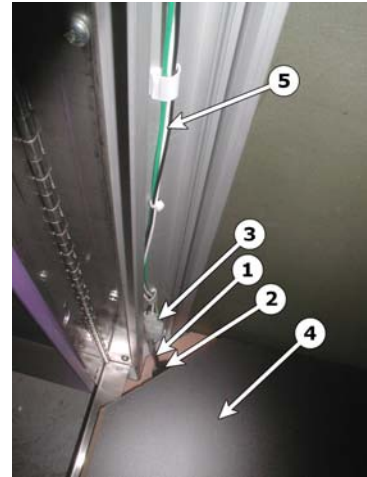

View inside looking down

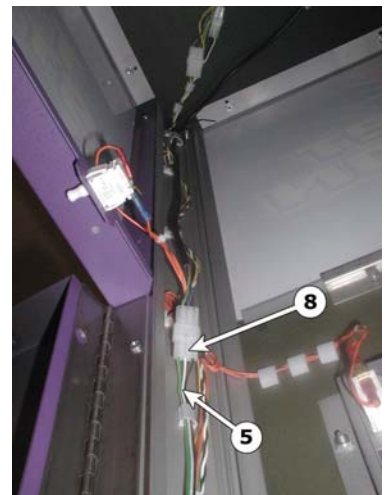

View inside looking up

2. Install ticket bags (see “Changing Ticket Bags” section of this manual).
3. Program barcode, machine number, etc. as desired (see “Programming section of this manual”).

General Operation

1. Insert tickets into the ticket taker using the easy load ticket ramp①. The LED display② will indicate the number of tickets counted and the Print Receipt Button③ will flash.
2. When all of the tickets have been fed into the machine, press the Print receipt button and wait for the printer to completely print the receipt. The receipt will feed to the front of the printer bezel④ and stop.
3. Pull the receipt straight out.
- 4.

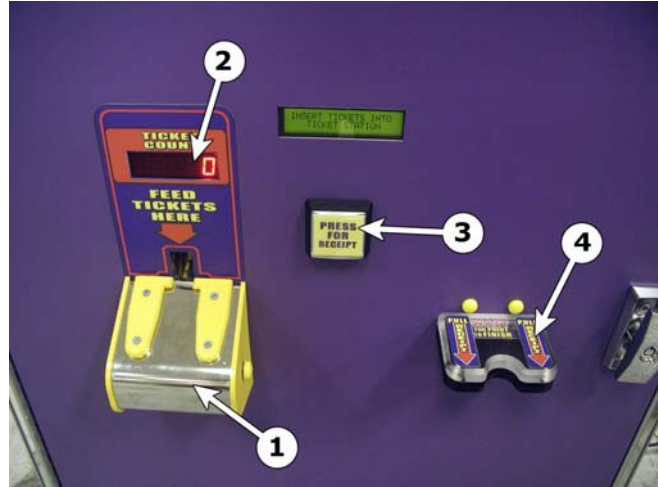

Air Blast Cleaning System

The Air blast cleaning system in the Ticket Station is comprised of an air pump, a relay, the main air hose plumbing, one air valve per ticket taker, and the local air hose plumbing that is distributed from a manifold after the air valve.

The cleaning cycle starts whenever any one of the ticket takers has taken 350 tickets. It restarts every 350 tickets thereafter.

At the beginning of the cleaning cycle, the pump runs for about 10 seconds to build pressure in the system. The air solenoid corresponding to the ticket taker that has taken the 350 tickets is then activated, releasing an air blast over the barcode scanners and opto sensors.

Changing Ticket Bags

1. Open front door.
2. Remove basket containment rail①.
3. Remove front ticket basket②, pull ticket bag through the bottom of the basket, and remove ticket bag.
4. Repeat step 3 for the rear ticket bag.
5. Replace ticket bags and basket containment rail.

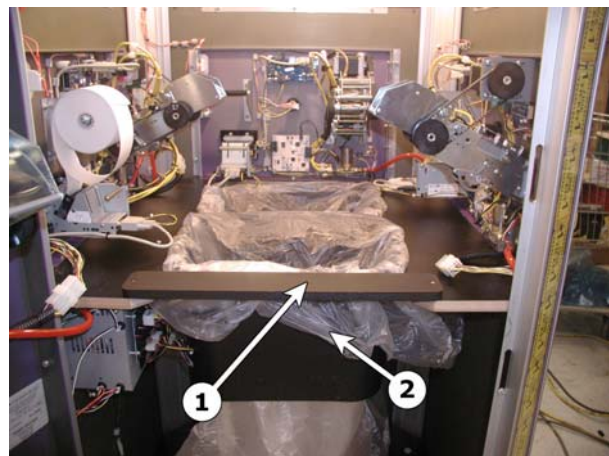

Loading Printer Paper

The printer will take different paper roll sizes. Small paper rolls (usually 7/16" diameter core) should be loaded on the small spindle② located on the printer assembly. The largest paper roll that can be used on the small spindle is 2-3/4" diameter. Large paper rolls (1 1/16" diameter core) are loaded on the large spindle④ located above the printer assembly on the door. The largest paper roll that can be used on the large spindle is 6".

Note: *The printer will only print on one side of the paper. Pay attention to the orientation of the paper roll when installing.*

Loading Small Rolls

1. Turn the roller release handle① counter clockwise ¼ turn so that the paper will be allowed to feed into the printer.
2. Load the paper onto the small spindle② so that the free end is fed from the bottom of the roll and over the guide rail③.
3. Feed paper as shown in the picture on the side of the printer.
4. Turn the roller release handle① clockwise ¼ turn into the ready position. The printer will automatically feed.
5. Tear excess from bezel.

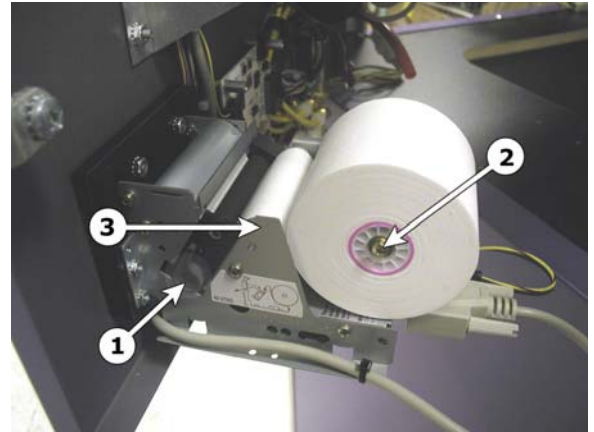

Loading Large Rolls

1. Turn the roller release handle① counter clockwise ¼ turn so that the paper will be allowed to feed into the printer.
2. Load the paper onto the large spindle④ with the free end of the paper facing down and away from the door.
3. Feed the paper under the small spindle②, over the ticket guide rail③ and into the printer.
4. Turn the roller release handle① clockwise ¼ turn into the ready position. The printer will automatically feed.
5. Tear excess from bezel.

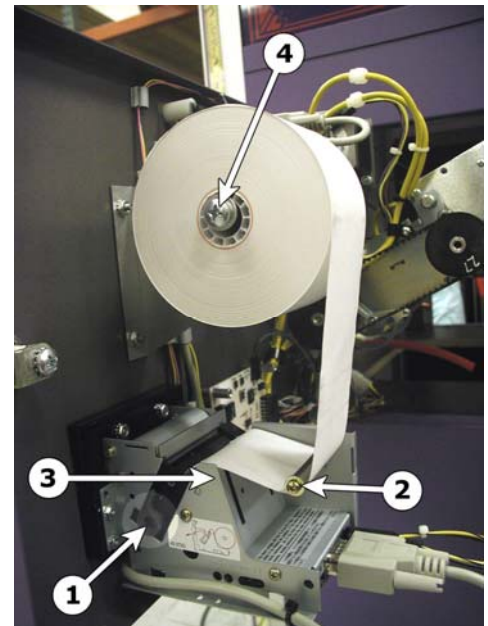

Tower Light Status

The tower light located on the top of the Ticket Station will let you know from across the room if something in the machine needs attention. You can further narrow the location of the problem from outside the machine by looking at the LCD display on each door. The door with the problem will have an error code on it. Here is what the lights indicate:

White Light Flashing indicates power and is used as an attraction so customers can easily locate the machine

White Light Solid indicates that it is time to change the bag containing discarded tickets.

Red Light Solid indicates that there is a ticket taker problem. Refer to troubleshooting section of this manual.

Yellow Light Solid indicates that there is a problem with the printer. This is most often seen when a printer need paper. If the printers do not need paper, refer to the troubleshooting section of this manual.

Ticket Taker General

Note: When a door is open for service, the lockout switch kills the 24V to the corresponding door. This keeps the ticket taker from operating for safety. If you must activate the power at the lockout switch for troubleshooting or programming, use caution around the ticket taker belts and cutters. **ALWAYS STAY CLEAR OF THE TICKET CUTTERS.**

Ticket Taker Overview

The ticket takers are comprised of 4 main parts plus the drive motor:

1. Ticket taker main body includes:
 - a. Ticket sense transmitter①
 - b. Lower urethane roller②

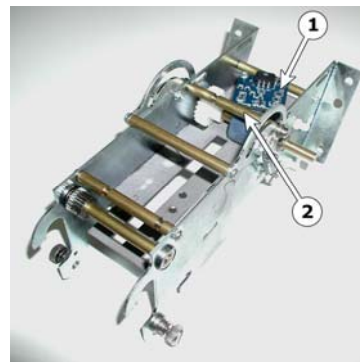

2. Ticket taker top assembly includes:
- a. Upper urethane roller①
 - b. Ticket sense opto receiver②
 - c. Notch sense opto receiver③
 - d. Upper barcode scanner④
 - e. Blue flat springs⑤

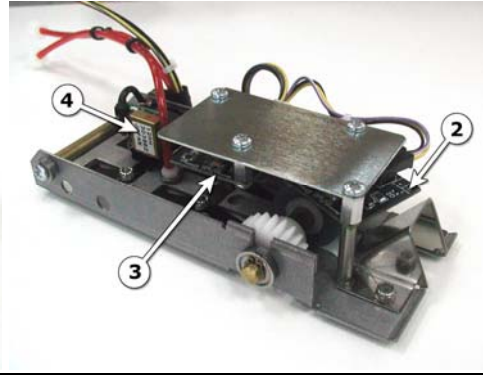
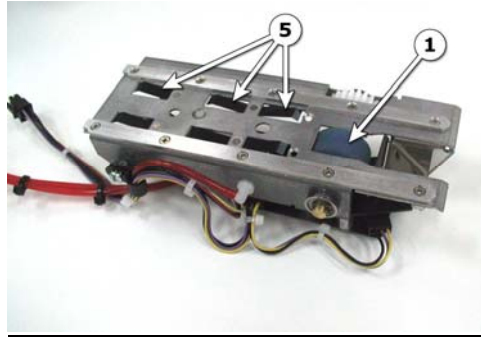

-
3. Ticket taker belt assembly includes:
- a. Ticket transport belts①
 - b. Lower barcode scanner②
 - c. Notch opto transmitter③

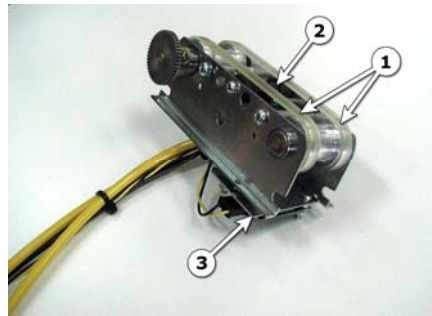

-
4. Ticket taker cutter assembly



-
5. Drive motor assembly includes:
- a. Stepper motor①
 - b. Hall effect sensor②

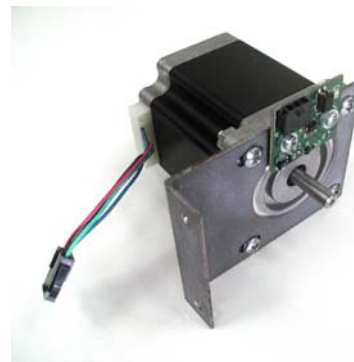

Ticket Taker Operation

When ticket is inserted the ticket taker, the ticket sense opto is interrupted which starts the ticket taker drive motor. The urethane rollers take the ticket(s) to the transport belts which carry the ticket(s) to the cutters. There are blue flat springs in the top assembly that push down on the top assembly keeping the ticket down on the transport belts. During the ticket travel over the transport belts, the notch opto senses the center notch of the tickets and the upper and lower side of the ticket is scanned for a barcode. We sense that the motor is turning with a hall effect sensor which is activated by a magnet located in the motor pulley passing over the circuit board. If there is no signal pulsing from the hall effect sensor when the motor is supposed to be running, the power to the motor will be turned off.

Clearing a Ticket Jam

1. Loosen captive thumbscrew① (1 each side)
2. Tilt cutter assembly② down
3. Use brass handle③ to pull top assembly④ back and up to remove.
4. Remove jammed tickets.
5. Carefully replace top assembly.
6. Tilt cutter assembly up and refasten thumbscrew

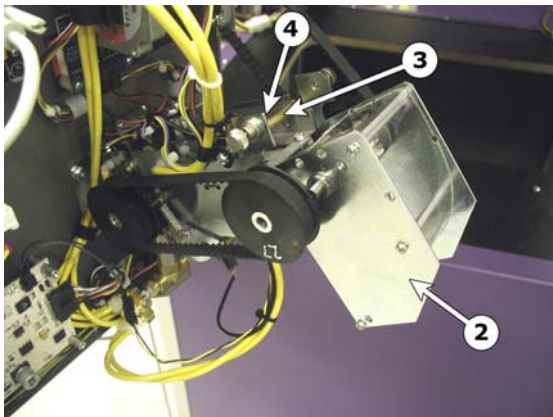
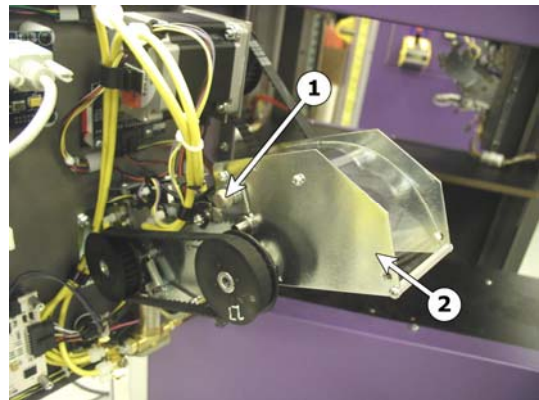

Cutter Assembly Shown Tilted Down

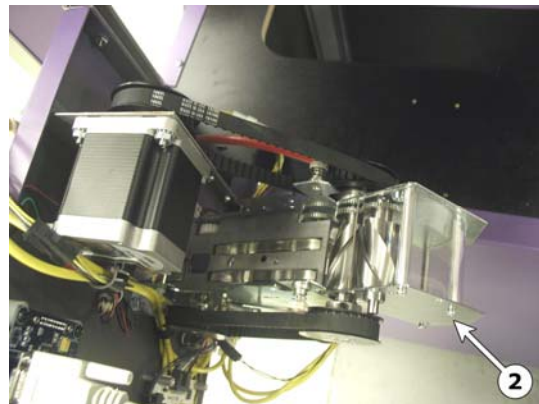

Top Assembly Shown Removed

Troubleshooting Guide

Note: There are (2) power distribution circuit boards mounted to the power supply housing. Each board holds (3) fuses, one 5V & two 12V. If there is a DC power problem, check these fuses.

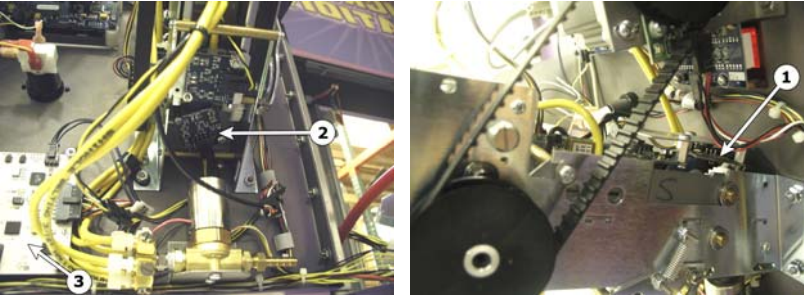
Ticket Taker will not start	<ol style="list-style-type: none">1. Check ticket sense opto pair. <u>LED</u> should come on and power output should pull to ground on <u>the ticket sense opto receiver</u>① when opto is blocked by ticket. Check for good power and ground to <u>ticket sense opto transmitter</u>② and <u>ticket sense opto receiver</u>①.2. Check for good signal <u>to ticket eater pcb</u>③ input from <u>ticket sense opto receiver</u>①3. Check all ticket eater motor connections <div data-bbox="565 898 1365 1192"></div>
Ticket Taker runs continuously	<ol style="list-style-type: none">1. Ticket sense opto path is blocked; check for ticket or debris.2. Bad ticket sense opto receiver or transmitter.

**Ticket Taker
runs slowly
then stops**

Hall effect pcb① output not getting to the ticket eater board.

1. Check that when the motor is running, the LED② on the hall effect pcb① is flashing at least one time per motor revolution. If the LED does not flash:
 - a. Check to see if the motor pulley③ is tight on the motor shaft.
 - b. Check the distance of the motor pulley from the hall effect sensor pcb. There is a magnet on the inside of the motor pulley that activates the sensor every revolution. If the pulley is located too far from the sensor pcb, the magnetic strength will be too weak to activate the sensor.
 - c. Check voltage to the hall effect pcb
- If the LED does flash, check the output of the hall effect sensor pcb all the way to the ticket eater pcb

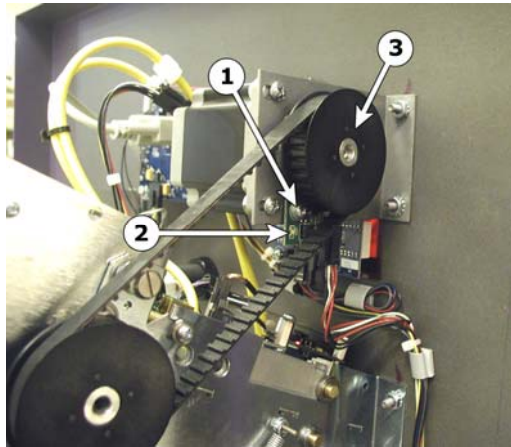

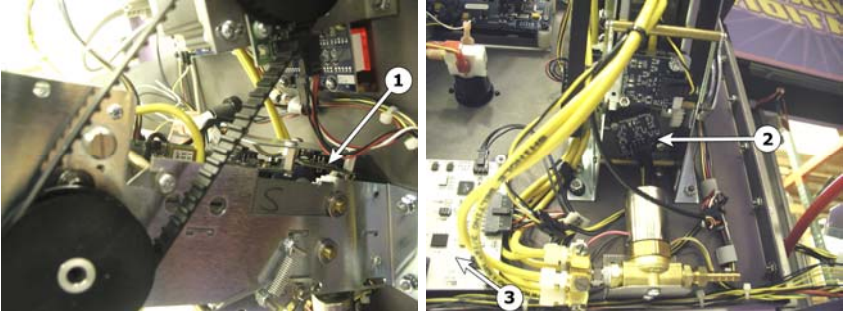
<p>Ticket Taker will not count with Ticket inserted in any direction</p>	<ol style="list-style-type: none"> 1. Check notch count opto pair. <u>LED on notch opto receiver</u>① should flash as tickets are fed into ticket taker. <ol style="list-style-type: none"> a. If LED does not flash, check power to the <u>notch opto transmitter</u>② and notch opto receiver①. b. If LED is always on, something is blocking the opto path or the opto is dirty. 2. If LED does flash, check output of notch count opto all the way to the ticket eater pcb. 3. Check power to barcode pcb's and output all the way back to ticket eater pcb③. 
<p>Ticket Taker counts accurately with barcode only up or only down</p>	<ol style="list-style-type: none"> 1. Check power to and output from barcode scanner pcb corresponding to the side that does not work.
<p>Ticket count is intermittent</p>	<p>To help diagnose the problem, you can, through programming options, change the ticket verification to notch from barcode. If the ticket count becomes accurate, the problem is related to the barcode. If the count is still intermittent, the problem is probably related to the notch opto sensors.</p> <ol style="list-style-type: none"> 1. Bad tickets with poor printing or out of spec barcode. 2. Clean barcode scanner pcb's and opto notch transmitter and receivers (if this works check pump operation and pneumatic cleaning system for leaks). 3. Check for loose wire connections to barcode scanners or opto notch optos
<p>Single tickets do not count accurately</p>	<p>Check that tickets travel through the ticket taker at a consistent rate without stopping or slowing dramatically.</p> <ol style="list-style-type: none"> 1. Check for debris in ticket eater 2. Check for equal spring pressure from the flat springs, make sure they are not bent 3. Check ticket transport belts for tracking, breakage, stretch or extreme wear

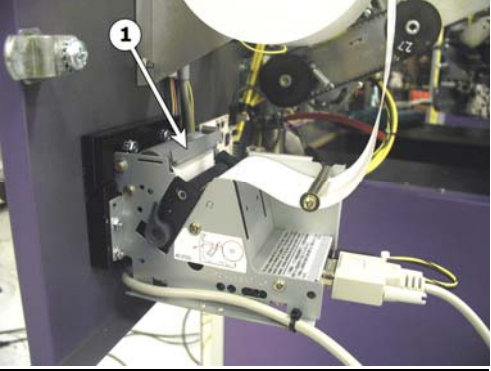
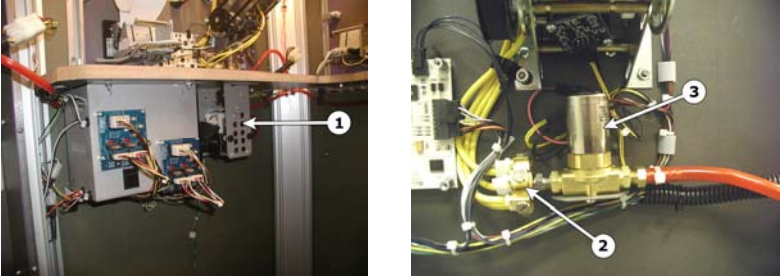
<p>Printer does not print</p>	<ol style="list-style-type: none"> 1. Out of paper 2. Paper installed backwards. The printer will only print on one side of the paper. See “Installing Printer Paper” section of this manual to verify correct installation. 3. <u>Paper guide plate</u>① pushed up. This plate needs to be all the way in the down position in order for the printer to print. If you find this in the up position, check to be sure receipt path is clear and that paper can be fed freely through the door. 
<p>Sensors need cleaning often</p>	<ol style="list-style-type: none"> 1. Make sure the <u>air pump</u>① comes on every 350 tickets. 2. Make sure there are no leaks in the main air plumbing 3. Make sure there are no leaks in the local air plumbing at the doors. Check air hose connections at the <u>air valve manifolds</u>②. <p>Note: If the problem is most often with one particular ticket taker, it is most likely a leak in the air plumbing system local to the door with the problem after the <u>air valve</u>③.</p>  <p>Shown with ticket baskets removed</p>

Programming

PLEASE NOTE: The lockout switch must be activated for all programming functions to work. Be sure to pull the plunger out to activate power to the ticket taker board before programming. Use caution as the ticket taker now has power. If at any time the message “COMM. ERROR” is displayed, there is a problem with communications between the boards, and programming is not possible. If this condition occurs, check to be sure lockout switch is activated, or turn off the machine, check all harness connections, insure that the power switch is on to the Ticket Eater board, and turn on the machine.

1.) Entering Programming Mode

To enter program mode, press and hold the PROGRAM button^② located on the back of the Printer Interface Board (the board with the LCD display). After 2 seconds, “PROGRAM MODE” will appear on the LCD Display. At this time, release the button. Momentarily, “PLEASE WAIT” will appear while the Totals are retrieved. At this time “TOTAL TICKETS” with the number of tickets taken in will be displayed.

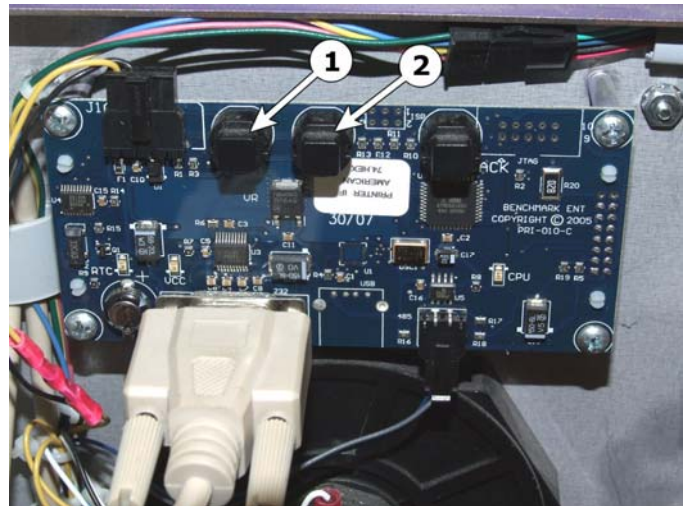

2.) TOTAL TICKETS

The total tickets taken in are displayed. The total will rollover to zero when it reaches 10,000,000. Depressing the NEXT button^① will display “ENTER PROGRAM MODE?”.

3.) “ENTER PROGRAM MODE?”

Depressing the PROGRAM button at this time will enter the area of Program Mode where parameters may be changed. Depressing the NEXT button will return the game to Run Mode.

4.) “DATE/TIME”

If Program Mode has been entered, the first setting is the Date and Time. The cursor will be flashing and at the Month position. Depressing the PROGRAM button will step through the month from 01 to 12. Depressing the NEXT button will move the cursor to the Day position. Enter the Day using the PROGRAM button. Depressing the NEXT button will move the cursor to the Year position. Depressing the PROGRAM button will increment the Year from 00 to 99. Depressing the NEXT button will move the Cursor the Hour position. The time is set in 24-Hour format. Depressing the PROGRAM button will increment the Hour from 00 to 24 Hours. Depressing the NEXT button will move the cursor to the Minutes position.

Depressing the PROGRAM button at this time will increment the minutes from 00 to 59. Depressing the NEXT button will go to the next option, “ENTER MACHINE NUMBER”

5.) “ENTER MACHINE NUMBER”

The machine number for each unit can be set from 0 to 99. Depressing the PROGRAM button will increment this value, and depressing the NEXT button will move to the next option, BarCode entry.

7.) “ENTER BARCODE?”

Depressing the PROGRAM button will allow for entry/editing of the 4-Digit Interleaved 2 of 5 barcode present on the ticket for ticket validation. Depressing the NEXT button will skip this step.

8.) “BARCODE: 0000”

This option sets the 4-Digit barcode. The flashing cursor will be over the first digit. Depressing the PROGRAM button will change the value of this digit from 0 to 9 then back to 0. Depressing the NEXT button will move the cursor to the next digit. Continue in this manner until the last digit is entered, then depressing the NEXT button will move to the next option, “TICKET SECURITY”.

9.) TICKET SECURITY

This option sets the Level of ticket barcode validation used. The PROGRAM button will change the value from 0 to 2, then back to 0, and the NEXT button will move to the next option, “SAFETY MODE”. The Three security levels are as follows:

- LEVEL 0 – Notch Only Validation, no Barcode required
- LEVEL 1 - Barcode Validation, Standard (Recommended)
- LEVEL 2 – Barcode Validation, HIGH Security

10.) SAFETY MODE

This option sets the Safety Level of the ticket eaters. Off is the normal mode and is recommended. ON lessens the power of the ticket eaters. Depressing the PROGRAM button changes the setting, and depressing the NEXT button moves to the next option, “TICKET VALUE”

11.) TICKET VALUE

This option sets the value of each ticket. The PROGRAM button will change the value from 1 to 5, then back to 1, and depressing the NEXT button moves to the next option, “RECEIPT CHECKDIGIT”

12.) RECEIPT CHECKDIGIT

This option turns the checkdigit added to the receipt barcode on or off. The PROGRAM button will change the setting, and depressing the NEXT button moves to the next option, “CARDSWIPE ENABLE”

12.) CARDSWIPE ENABLE

This option is selected if one of the many available cardswipe systems is interfaced with the Ticket Station. Depressing the PROGRAM button scrolls through the three options which are OFF (Normal Operation), PULSE, and SERIAL. Contact your cardswipe system supplier for more information. Depressing the NEXT button moves to the next option, "EDIT DISPLAY?"

13.) "EDIT DISPLAY?"

Depressing the PROGRAM button will allow for editing of the "WELCOME TO" message that is displayed on the machine. Depressing the NEXT button will skip this step and go to "EDIT RECEIPT?". If the PROGRAM button is depressed, the display will show the current "WELCOME TO" message, and a flashing cursor will be at the beginning of the second line of the display, which is the only line that may be edited.

Editing the Display

Depressing the PROGRAM button will change the character at the flashing cursor. Every time the PROGRAM button is depressed, the next character in the list will be displayed. If the end of the list of characters is reached, the first in the list is displayed (refer to List of Characters at the end of this section). The line will appear exactly as it is edited, including leading and trailing spaces.

Depressing the NEXT button will move to the next character. If the flashing cursor is not at the beginning of the line and the BACK button is depressed, the flashing cursor will move to the previous character. Depressing the NEXT button when the flashing cursor is over the last character will save the displayed Welcome Message, and go to the next option, which is "EDIT RECEIPT?"

14.) "EDIT RECEIPT?"

Depressing the PROGRAM button will allow for editing of the first four lines of the receipt, as well as the line found after the ticket quantity is printed. Each of the five lines can be a maximum of 32 characters long, including spaces and punctuation. Depressing the NEXT button will skip this step and go to "RE-ENTER PROGRAM MODE?". If the PROGRAM button is depressed, the display will show the current first line of the receipt, and a flashing cursor will be at the beginning. The first twenty characters will be on the first line of the display, and the last twelve characters will be on the second line of the display. A black square will be displayed past the end of the 32 character line.

NOTE: If this option is selected, all 32 characters on all five lines must be stepped through to leave this option!

Editing the Receipt

All five lines on the receipt are edited in the same way. It is recommended that the information that is desired for the five lines be written out in advance to insure that the 32 character limit isn't exceeded. The lines should be edited with NO leading spaces. Each line will be automatically centered on the receipt when it is printed. Depressing the PROGRAM button will change the character at the flashing cursor. Every time the PROGRAM button is depressed, the next character in the list will be

displayed. If the end of the list of characters is reached, the first in the list is displayed (refer to List of Characters at the end of this section).

Depressing the NEXT button will move to the next character. If the flashing cursor is not at the beginning of the line and the BACK button is depressed, the flashing cursor will move to the previous character. Depressing the NEXT button when the flashing cursor is to the left of the black square will save the line and the next line will be displayed for editing. If it is the fifth line, the next option will be shown, "RE-ENTER PROGRAM MODE?"

15.)RE-ENTER PROGRAM MODE?

This option gives you the opportunity to go through the programming settings again. Depressing the PROGRAM button will re-enter the Program Mode at the beginning, and depressing the NEXT button will leave Program Mode, and return to Run Mode.

CHARACTER LIST for DISPLAY and RECEIPT EDITING

[SPACE] ! " # \$ % & ' () * + , - . / 0 1 2 3 4 5 6 7 8 9 : ; < > ? @
A B C D E F G H I J K L M N O P Q R S T U V W X Y Z [*] ^
_ \ a b c d e f g h I j k l m n o p q r s t u v w x y z

ERROR CODES

The LCD Display on the Ticket Station will show common error codes to help in troubleshooting. There are two Types of errors; those associated with the Ticket Eater and those associated with the Printer. The LCD Display will show which type of error it is, "TICKET ERROR" or "PRINTER ERROR" along with the associated error number.

The Errors are as follows:

1.) Ticket Errors:

ERROR 1: Ticket Jam

2.) Printer Errors:

ERROR 1: Printer Platen Open

ERROR 2: Printer Out Of Paper

ERROR 3: Printer Head Temperature Abnormal

ERROR 4: Printer Cutter Cover Open (usually indicates a Paper Jam)









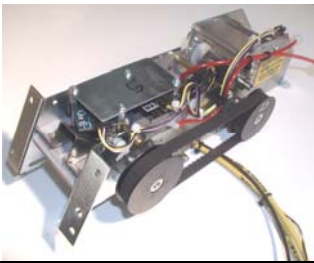
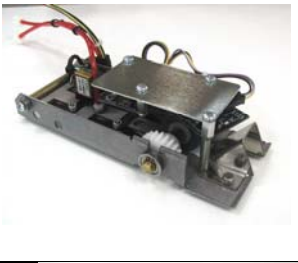

ERROR 5: Printer Communications Failure





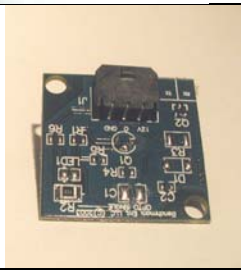
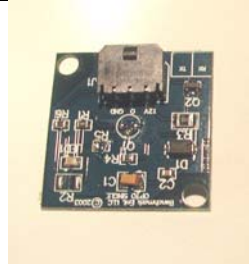

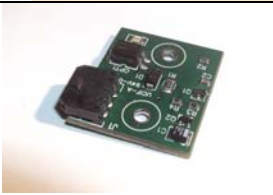
NOTE:

If one of Errors 1 through 4 occur in the middle of a receipt print, the Printer may default to ERROR 5. Insure that all of the possible errors are checked before assuming a communications failure.

If the Printer is in the middle of printing the receipt and runs out of paper, it will retain the information for that receipt AS LONG AS POWER IS NOT TURNED OFF TO THE PRINTER. Reload the paper without turning the printer off and it will complete the printing of the last receipt.

Parts List

<p>87-ASM-24 Ticket Taker</p> 	<p>87-ASM-25 Ticket Taker Top</p> 
<p>87-ASM-26 Ticket Taker Belt Assy.</p> 	<p>87-ASM-27 Ticket Taker Body</p> 
<p>87-ASM-28 Ticket Cutter</p> 	<p>87-ASM-45 Ticket Taker Stepper Motor</p> 
<p>87-ASM-46 Solenoid Valve Assy.</p> 	<p>PCB-020 Opto Transmitter Single</p> 
<p>PCB-021 Opto Receiver Single</p> 	<p>PCB-022 Barcode Reader</p> 
<p>PCB-026 Hall Effect Sensor</p> 	<p>PCB-027 Printer Driver Board</p> 

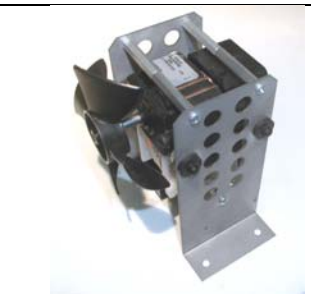
<p>PCB-028 Stepper driver single white series</p>		<p>87-SHM-06 Spring Tab Bent</p>	
<p>ELM-021 Lockout Switch</p>		<p>ELM-022 Tower Light, 3 color</p>	
<p>PCB-029 5 digit led display</p>		<p>ELM-023 Printer, Thermal</p>	
<p>MOT-004 Air Pump</p>			

12 PIN CONNECTOR DOOR 1

- 12 12 VOLTS COMMON 22 GA YELLOW
- 11 GND SIGNAL 22 GA BLACK
- 10 12 VOLTS 18 GA YELLOW
- 9 ✗ 22 GA YELLOW/GREEN
- 8 GREEN/WHITE
- 7 WHITE/BLACK/RED
- 6 GND 18 GA BLACK
- 5
- 4 22 GA RED 5 VOLTS
- 3 GND 18 GA BLACK
- 2 WHITE/BLK/GREEN
- 1

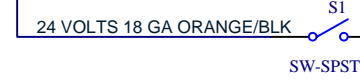

N CONNECTOR DOOR 2

- 12 12 VOLTS COMMON 22 GA YELLOW
- 11 22 GA SIGNAL GND BLACK
- 10 12 VOLTS 18 GA YELLOW
- 9 ✗ 22 GA YELLOW/GREEN
- 8
- 7 ✗ WHITE/BLACK/RED
- 6 GND 18 GA BLACK
- 5 24 VOLTS 18 GA ORANGE/WHITE
- 4 22 GA RED
- 3 GND 18 GA BLACK
- 2 WHITE/BLK/GREEN
- 1

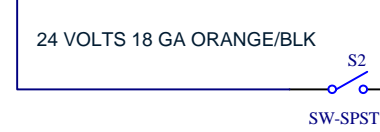

PIN CONNECTOR DOOR 3

- 12 12 VOLTS COMMON 22 GA YELLOW/WHITE
- 11 GND SIGNAL 22 GA BLACK/WHITE
- 10 12 VOLTS 18 GA YELLOW/WHITE
- 9 ✗ 12 VOLTS COMMON 22 GA YELLOW/WHITE
- 8
- 7 ✗ WHITE/BLACK/RED
- 6 GND 18 GA BLACK/WHITE
- 5
- 4 22 GA 5 VOLTS RED/WHITE
- 3 GND 18 GA BLACK/WHITE
- 2 WHITE/BLK/GREEN
- 1



12 PIN CONNECTOR DOOR 4

- 12 12 VOLTS COMMON 22 GA YELLOW/WHITE
- 11 22 GA SIGNAL GND BLACK/WHITE
- 10 12 VOLTS 18 GA YELLOW/WHITE
- 9 ✗ 12 VOLTS COMMON 22 GA YELLOW/WHITE
- 8 ✗
- 7 WHITE/BLACK/RED
- 6 GND 18 GA BLACK/WHITE
- 5 24 VOLTS 18 GA ORANGE/WHITE
- 4 22 GA RED/WHITE
- 3 GND 18 GA BLACK/WHITE
- 2 WHITE/BLK/GREEN
- 1

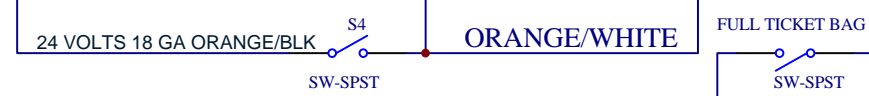

P1

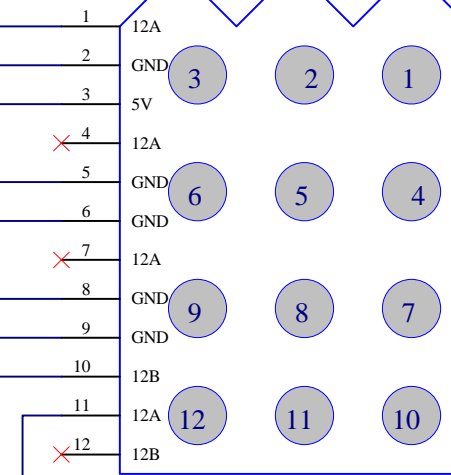

4 PIN MOLEX FEMALE

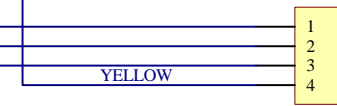

24 VOLT POWER 1



4 PIN MOLEX MALE MICRO_FIT



P2

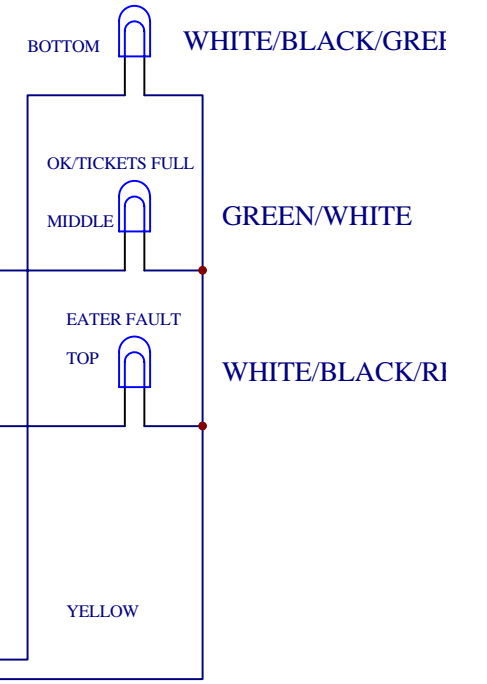
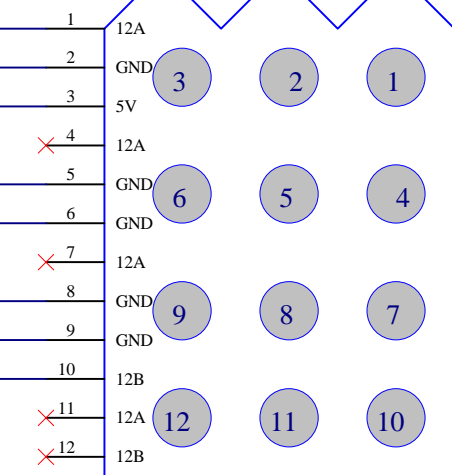

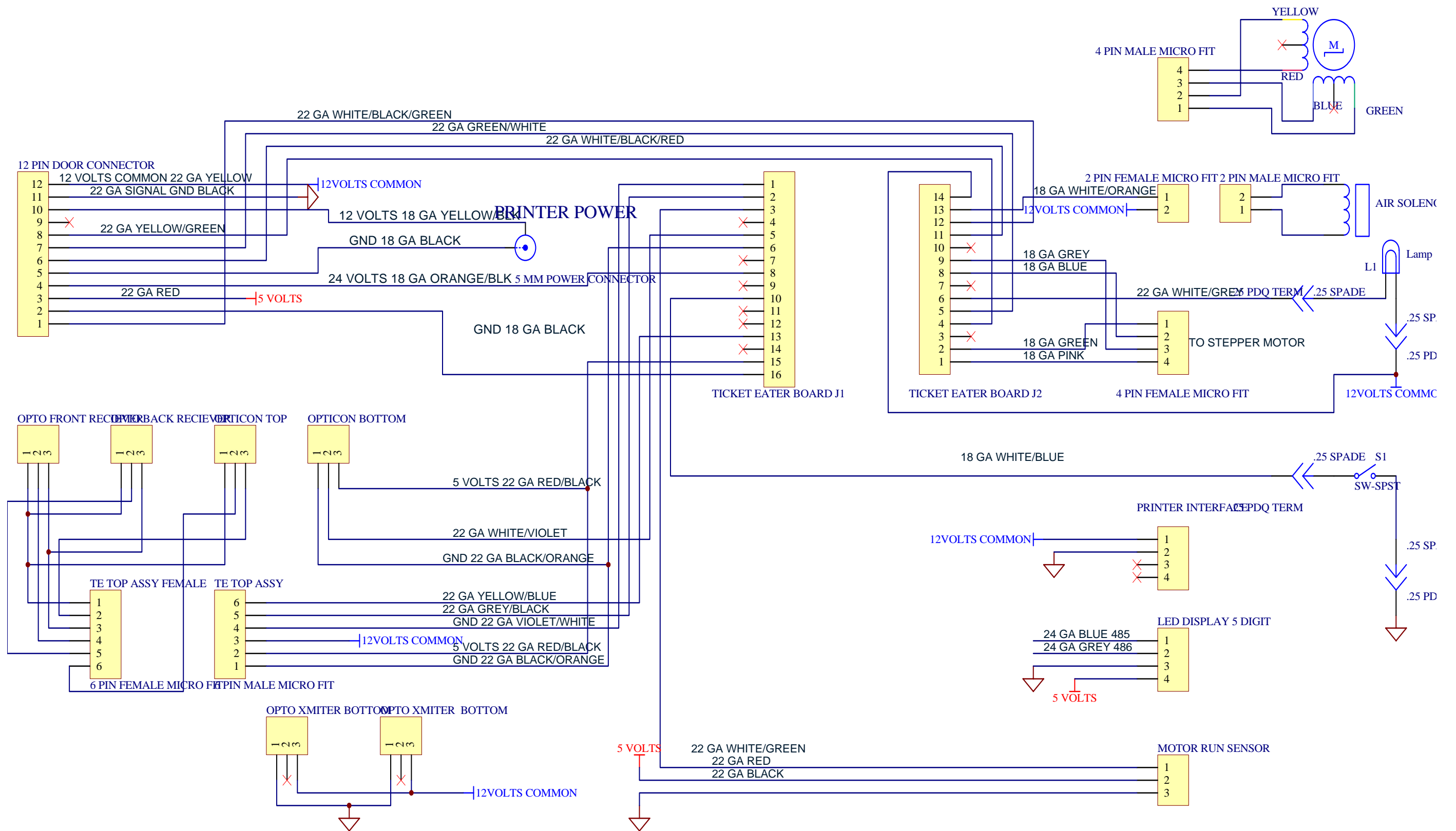

ITEM NO.	Description	Part Number	QTY.
1	ticket guide bracket	87-SHM-25	1
2	ticket guide rail	87-MAC-04	2
3	ticket guide end plate	87-MAC-03	2
4	ticket guide shim	87-SHM-50	2
5	ticket guide attach rod	87-SCM-52	1
6	ticket guide rail lower	87-MAC-12	1
7	ticket guide rod	87-SCM-57	1
8	Mirrorticket guide rail lower	87-MAC-13	1
9	CR-FHMS 0.138-32x0.75x0.75-N	N/A	4
10	MSHXNUT 0.138-32-D-N	N/A	4
11	screwnail 13x750	N/A	2

REVISIONS			
ZONE	REV	DESCRIPTION	DATE
	A	Release to Production	07/28/07

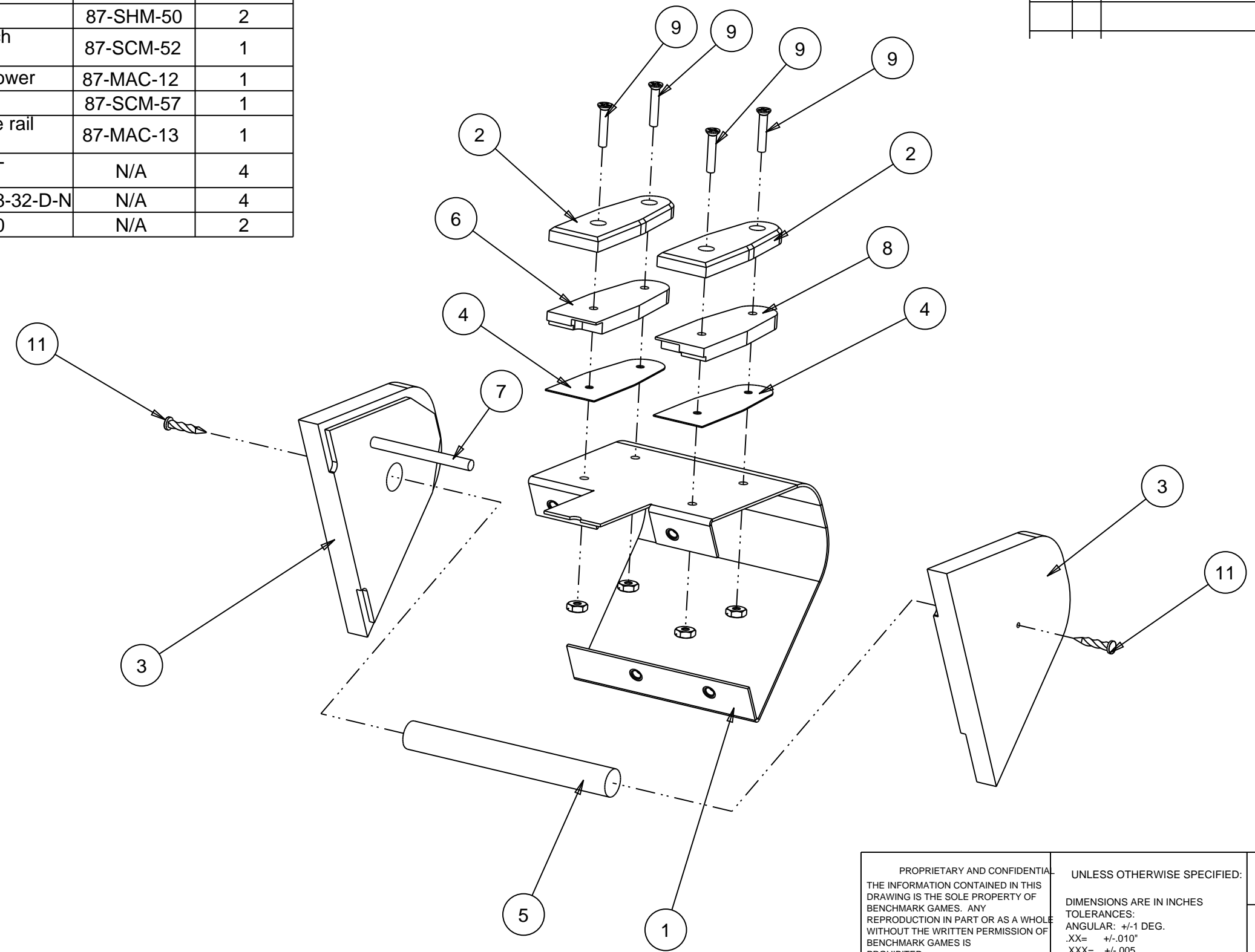

PROPRIETARY AND CONFIDENTIAL THE INFORMATION CONTAINED IN THIS DRAWING IS THE SOLE PROPERTY OF BENCHMARK GAMES. ANY REPRODUCTION IN PART OR AS A WHOLE WITHOUT THE WRITTEN PERMISSION OF BENCHMARK GAMES IS PROHIBITED.	UNLESS OTHERWISE SPECIFIED: DIMENSIONS ARE IN INCHES TOLERANCES: ANGULAR: +/-1 DEG. .XX= +/-0.10" .XXX= +/-0.005 .XXXX= +/-0.003	Benchmark Games	
	DRAWN BY: S. Corso	TITLE: ticket guide assembly	
MATERIAL	COMMENTS:	SIZE B	DWG. NO. 54-ASM-04
FINISH		SCALE: 1:2	WEIGHT:
		SHEET 1 OF 1	

ITEM NO.	Description	Part Number	QTY.
1	ticket eater top	87-ASM-25	1
2	belt assembly ticket taker	87-ASM-26	1
7	cutter steep pitch	87-ASM-28	1
12	27XL .375 wide timing belt	GER-015	1
13	29XL .375 wide timing belt	GER-014	1
14	shoulder washer #4idx185x375	87-SCM-59	2
15	CR-PHMS 0.112-40x0.375x0.375-N	N/A	2
16	nut fiberlock 440	N/A	2

REVISIONS			
ZONE	REV	DESCRIPTION	DATE
	A	Release	07/26/07
	B	Update parts	07/27/07

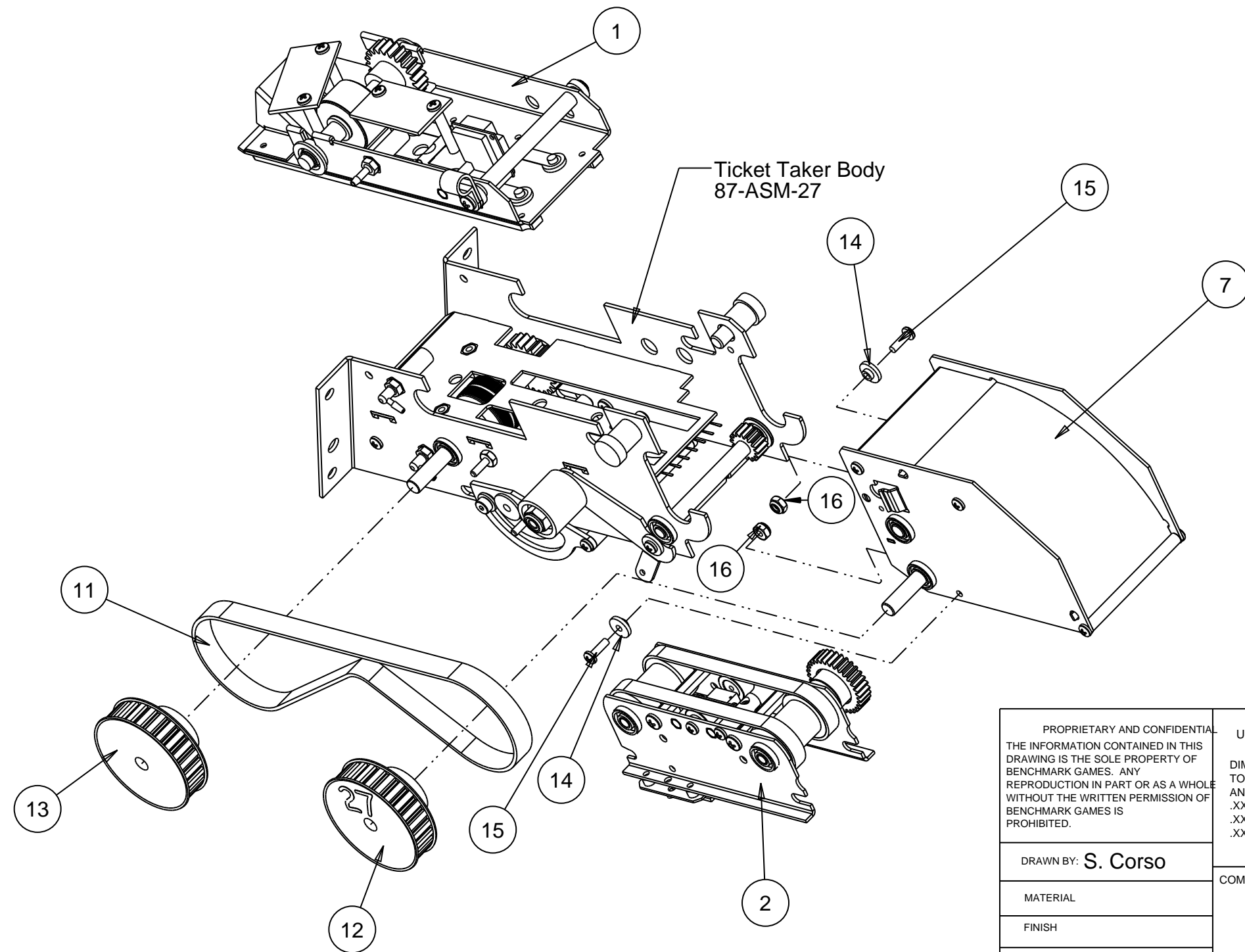

Ticket Taker Body
87-ASM-27

PROPRIETARY AND CONFIDENTIAL THE INFORMATION CONTAINED IN THIS DRAWING IS THE SOLE PROPERTY OF BENCHMARK GAMES. ANY REPRODUCTION IN PART OR AS A WHOLE WITHOUT THE WRITTEN PERMISSION OF BENCHMARK GAMES IS PROHIBITED.	UNLESS OTHERWISE SPECIFIED: DIMENSIONS ARE IN INCHES TOLERANCES: ANGULAR: +/-1 DEG. .XX= +/-0.010" .XXX= +/-0.005 .XXXX= +/-0.003	Benchmark Games	
	DRAWN BY: S. Corso	TITLE: ticket eater belt Complete	
MATERIAL	COMMENTS:	SIZE B	DWG. NO. 87-ASM-24
FINISH	SCALE: 1:2	WEIGHT:	REV SHEET 1 OF 6

ITEM NO.	Description	Part Number	QTY.
1	ticket eater top top cover shtm	87shm11	1
2	barcode scan LBSAM12	PCB-022	1
3	BARBED FITTING 011032FA12N	GEN-010	2
4	ticket eater top cover spacer	87scm15	1
5	shoulder washer #6	87scm22	2
6	roller top	87-ASM-30	1
7	AFBMA 12.2 - 0.2500 - 0.5000 - 0.1250 - 12.SI.NC.12	BRG-010	2
8	retaining ring external 250 shaft	HAR-021	2
9	ticket eater tunnel block	87-SHM-54	1
10	spring plunger	87-SCM-03	6
11	spacer .094id 250od 06L	N/A	4
12	spring flat plunger	87-SHM-73	3
13	opto receiver small		2
14	MSHXNUT 0.086-56-D-N	N/A	4
15	CR-PHMS 0.086-56x0.25x0.25-N	N/A	2
16	CR-PHMS 0.112-40x0.25x0.25-N	N/A	4
17	CR-PHMS 0.138-32x0.375x0.375-N	N/A	2
18	cable_clamp_250	N/A	1
19	track 3	87-MAC-01	2

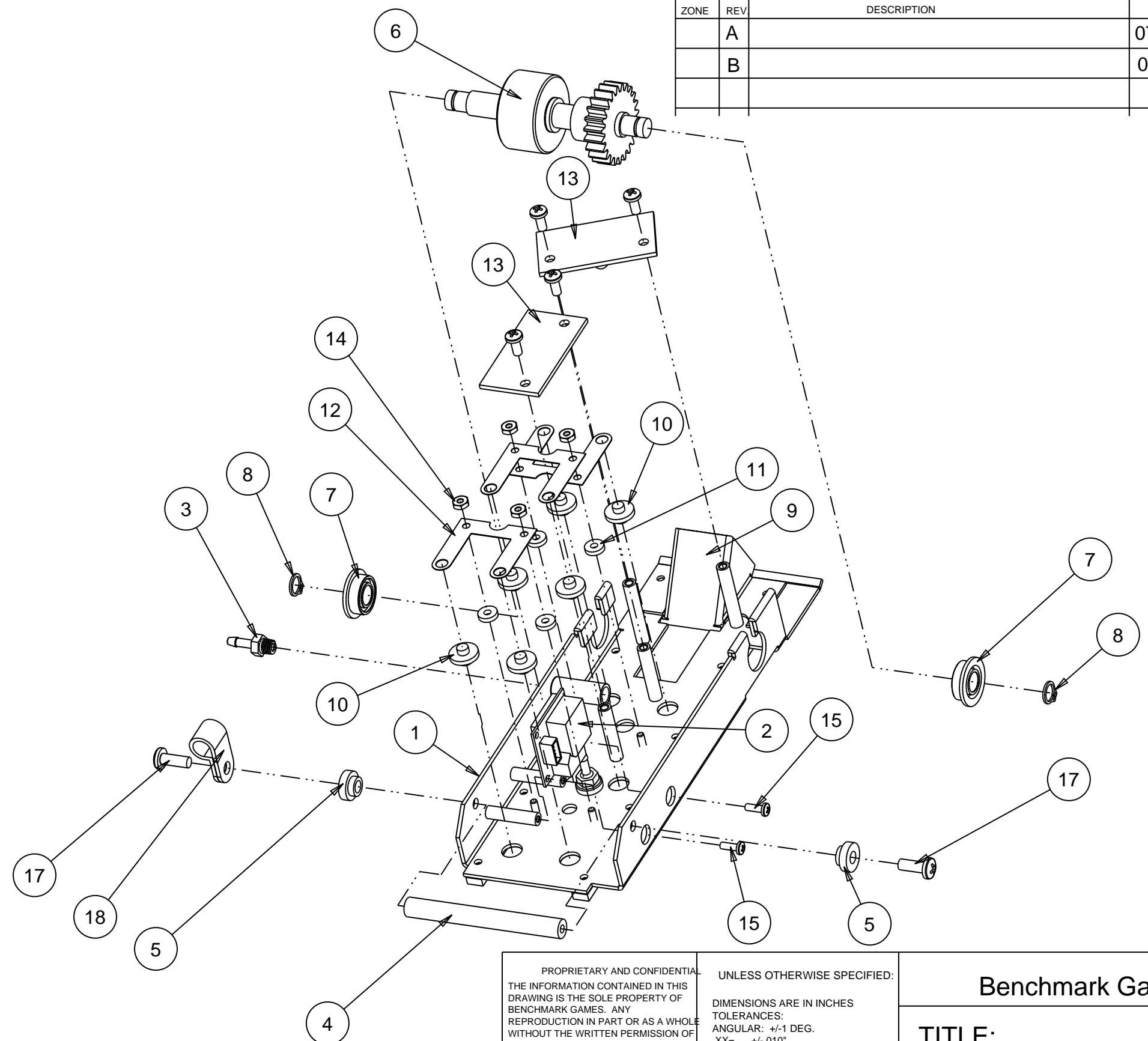

REVISIONS			
ZONE	REV	DESCRIPTION	DATE
	A		07/26/07
	B		07/27/07

PROPRIETARY AND CONFIDENTIAL THE INFORMATION CONTAINED IN THIS DRAWING IS THE SOLE PROPERTY OF BENCHMARK GAMES. ANY REPRODUCTION IN PART OR AS A WHOLE WITHOUT THE WRITTEN PERMISSION OF BENCHMARK GAMES IS PROHIBITED.		UNLESS OTHERWISE SPECIFIED: DIMENSIONS ARE IN INCHES TOLERANCES: ANGULAR: +/-1 DEG. .XX= +/-0.10" .XXX= +/-0.005 .XXXX= +/-0.003		Benchmark Games	
DRAWN BY: S. Corso		COMMENTS:		TITLE: ticket eater belt Top Assembly (87-ASM-25)	
MATERIAL		FINISH		SIZE B	DWG. NO. 87-ASM-24
				SCALE: 1:1.5	WEIGHT:
				SHEET 2 OF 6	

ITEM NO.	Description	Part Number	QTY.
1	barcode scan LBSAM12	PCB-022	1
2	belt pulley assy long	87-ASM-47	1
3	spacer ticket belt assembly	87-SCM-25	2
4	belt assembly cover left	87-SHM-02	1
5	AFBMA 12.2 - 0.1875 - 0.5000 - 0.1960 - 8.SI.NC.8	BRG-001	4
6	1/2 inch - Spur gear 32DP 32T 14.5PA .1875FW --- S32N.75H.75L0.1875N	87-GER-02	1
7	belt assembly cover	87-ASM-61	1
8	urethane belt		2
9	CR-PHMS 0.138- 32x0.188x0.188-N	N/A	4
10	CR-PHMS 0.086- 56x0.25x0.25-N	N/A	2
11	collar shaft 250	HAR-034	1
12	opto receiver square		1
13	MSHXNUT 0.112-40-D-N	N/A	2
14	belt pulley assy short	87-ASM-48	1

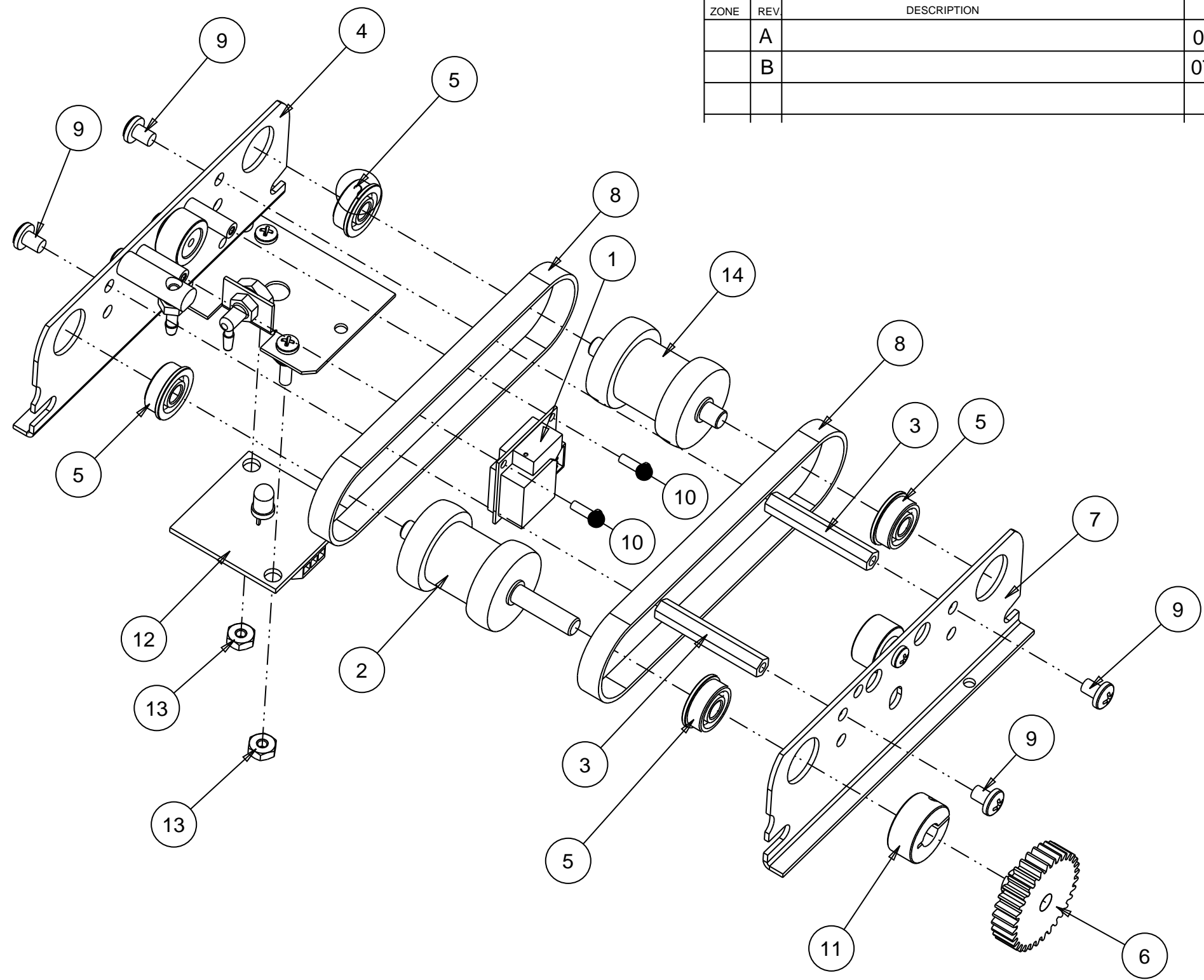

REVISIONS			
ZONE	REV	DESCRIPTION	DATE
	A		07/26/07
	B		07/27/07

PROPRIETARY AND CONFIDENTIAL THE INFORMATION CONTAINED IN THIS DRAWING IS THE SOLE PROPERTY OF BENCHMARK GAMES. ANY REPRODUCTION IN PART OR AS A WHOLE WITHOUT THE WRITTEN PERMISSION OF BENCHMARK GAMES IS PROHIBITED.	UNLESS OTHERWISE SPECIFIED: DIMENSIONS ARE IN INCHES TOLERANCES: ANGULAR: +/-1 DEG. .XX= +/-0.010" .XXX= +/-0.005 .XXXX= +/-0.003	Benchmark Games		
	DRAWN BY: S. Corso	TITLE: ticket eater belt Belt Assembly (87-ASM-26)		
MATERIAL	COMMENTS:	SIZE B	DWG. NO. 87-ASM-24	REV
FINISH	SCALE: 1:1.2	WEIGHT:	SHEET 3 OF 6	

ITEM NO.	PART NUMBER	DESCRIPTION	QTY.
1	idler pulley pin	87-SCM-02	1
2	idler pulleywo flanges	87-SCM-01	1
3	count opto mount plate	87-SHM-19	1
4	BARBED FITTING 011032FA12N	GEN-010	1
5	spacer belt assembly jet	87-SCM-25	1
6	nut fiberlock 440	N/A	2
7	CR-PHMS 0.112-40x0.5x0.5-N	N/A	2
8	CR-PHMS 0.112-40x0.188x0.188-N	N/A	2
9	90 deg fitting 062	GEN-014	1
10	MSHXNUT 0.190-32-D-N	N/A	1
11	spacer #4 x 188od x 125L	N/A	2
12	belt assembly cover right shm	87-SHM-01	1

REVISIONS			
ZONE	REV	DESCRIPTION	DATE
	A		07/26/07
	B		07/27/07

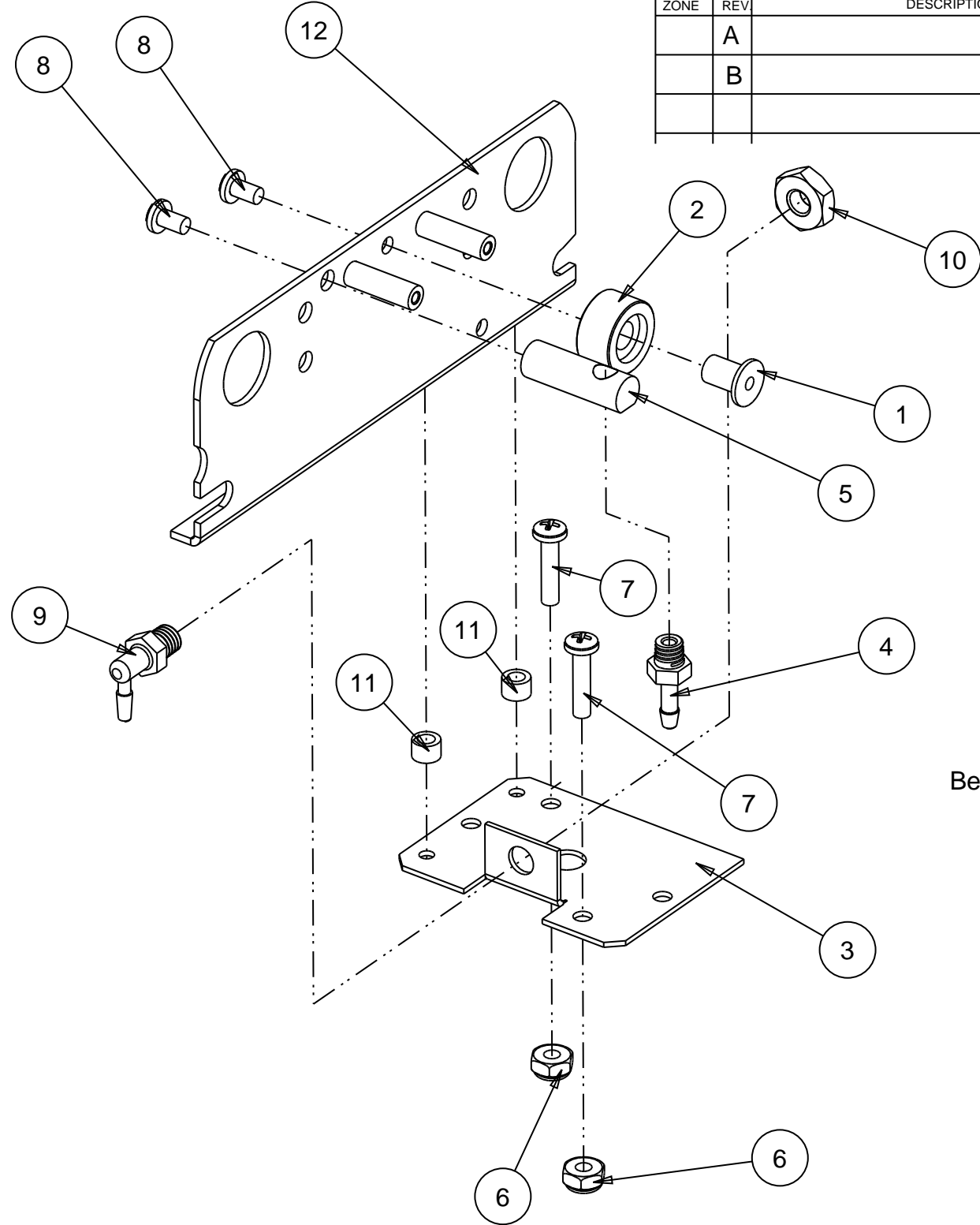

Belt Assembly Cover Left

ITEM NO.	PART NUMBER	DESCRIPTION	QTY.
1	idler pulleywo flanges	87-SCM-01	1
2	belt assembly cover	87-SHM-01	1
3	idler pulley pin	87-SCM-02	1
4	CR-PHMS 0.112-40x0.188x0.188-N	N/A	1

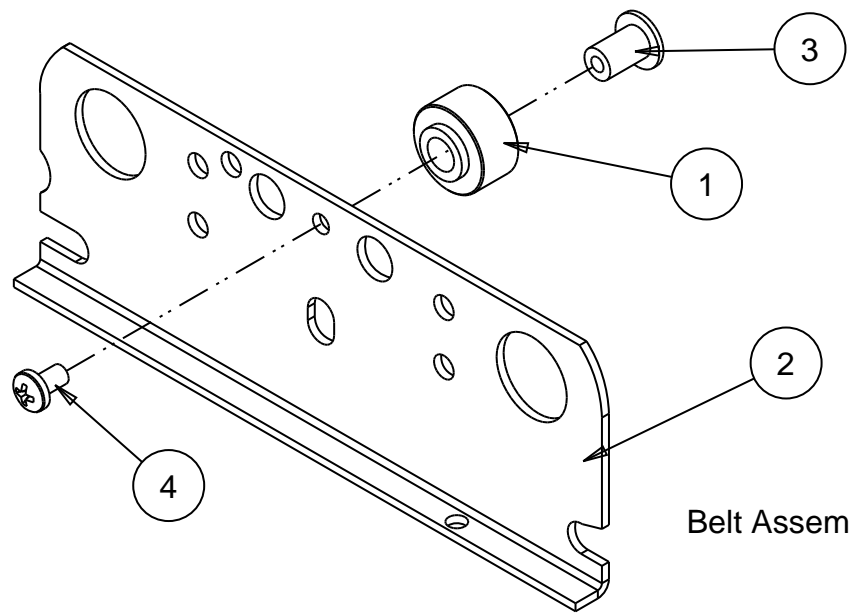

Belt Assembly Cover

PROPRIETARY AND CONFIDENTIAL THE INFORMATION CONTAINED IN THIS DRAWING IS THE SOLE PROPERTY OF BENCHMARK GAMES. ANY REPRODUCTION IN PART OR AS A WHOLE WITHOUT THE WRITTEN PERMISSION OF BENCHMARK GAMES IS PROHIBITED.	UNLESS OTHERWISE SPECIFIED: DIMENSIONS ARE IN INCHES TOLERANCES: ANGULAR: +/-1 DEG. .XX= +/-0.010" .XXX= +/-0.005 .XXXX= +/-0.003	Benchmark Games	
	DRAWN BY: S. Corso	TITLE: ticket eater belt Belt Assembly Cover (87-ASM-61) Belt Assembly Cover Left (87-ASM-62)	
MATERIAL	COMMENTS:	SIZE B	DWG. NO.
FINISH		SCALE: 1:1	WEIGHT:
		SHEET 4 OF 6	

ITEM NO.	Description	Part Number	QTY.
1	ticket eater top side shm	87-SHM-12	1
2	belt assembly release cam roller	87-SCM-51	2
3	shoulder bolt 125 x 125 x 440	N/A	2
4	belt assembly release handle	87-SCM-30	1
5	belt assembly release cam shm	87-SHM-45	1
6	shoulder washer #6x250x625	87-SCM-50	2
7	belt assembly release cam right	87-SHM-78	1
8	AFBMA 12.2 - 0.1875 - 0.5000 - 0.1960 - 8.SI.NC.8	N/A	2
9	idler shaft assy	87-ASM-32	1
10	spacer top assembly	87-SCM-08	1
11	spacer belt assembly latch	87-SCM-06	1
12	spacer belt assembly mount	87-SCM-07	1
13	ticket eater bottom cover	87-SHM-07	1
14	roller shaft lower assy	87-ASM-31	1
15	ticket eater top side left	87-SHM-10	1
16	AFBMA 12.2 - 0.2500 - 0.5000 - 0.1250 - 12.SI.NC.12	N/A	2
17	CR-PHMS 0.138-32x0.188x0.188-N	N/A	2
18	CR-PHMS 0.112-40x0.25x0.25-N	N/A	5
19	CR-PHMS 0.138-32x0.375x0.375-N	N/A	2
20	opto transmitter square	PCB-020	1
21	CR-PHMS 0.112-40x0.375x0.375-N		1
22	90 deg fitting 062		2
23	idler arm side belt		1
24	shoulder washer #4idx185x375		1
25	MSHXNUT 0.112-40-D-N		4
26	static brush		1

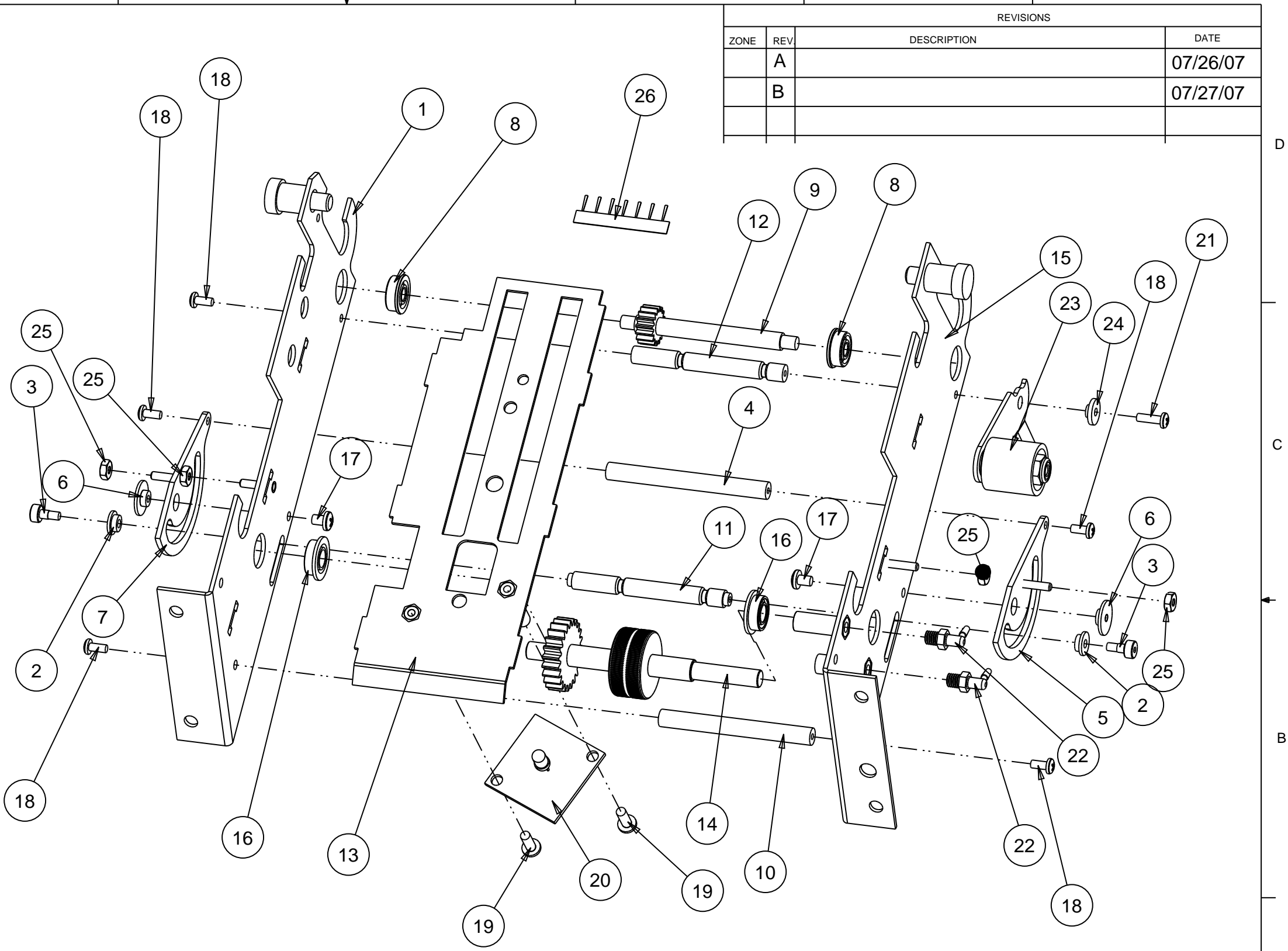

REVISIONS			
ZONE	REV	DESCRIPTION	DATE
	A		07/26/07
	B		07/27/07

PROPRIETARY AND CONFIDENTIAL THE INFORMATION CONTAINED IN THIS DRAWING IS THE SOLE PROPERTY OF BENCHMARK GAMES. ANY REPRODUCTION IN PART OR AS A WHOLE WITHOUT THE WRITTEN PERMISSION OF BENCHMARK GAMES IS PROHIBITED.	UNLESS OTHERWISE SPECIFIED: DIMENSIONS ARE IN INCHES TOLERANCES: ANGULAR: +/-1 DEG. .XX= +/-0.010" .XXX= +/-0.005 .XXXX= +/-0.003	Benchmark Games		
	DRAWN BY: S. Corso	TITLE: ticket eater belt Body Assembly (87-ASM-27)		
MATERIAL	COMMENTS:	SIZE B	DWG. NO. 87-ASM-24	REV
FINISH	SCALE: 1:1.66	WEIGHT:	SHEET 5 OF 6	

ITEM NO.	Description	Part Number	QTY.
1	spiral crosscut steep pitch	87-SCM-26	1
2	spiral crosscut steep pitch top	87-SCM-27	1
3	Gear Cutter Lower	87-GER-03	1
4	torsion spring	SPR-014	1
5	cutter spacer	87-SCM-14	3
6	cutter plate right	87-SHM-33	1
7	AFBMA 12.2 - 0.2500 - 0.5000 - 0.1250 - 12.SI.NC.12	BRG-010	4
8	roll_pin_063x250	N/A	1
9	cutter cover	87-SHM-51	1
10	Gear Cutter Upper	87-GER-04	1
11	CR-PHMS 0.112-40x0.25x0.25-N	N/A	6
12	cutter plate left	87-SHM-32	1

REVISIONS			
ZONE	REV	DESCRIPTION	DATE
	A		07/26/07
	B		07/27/07

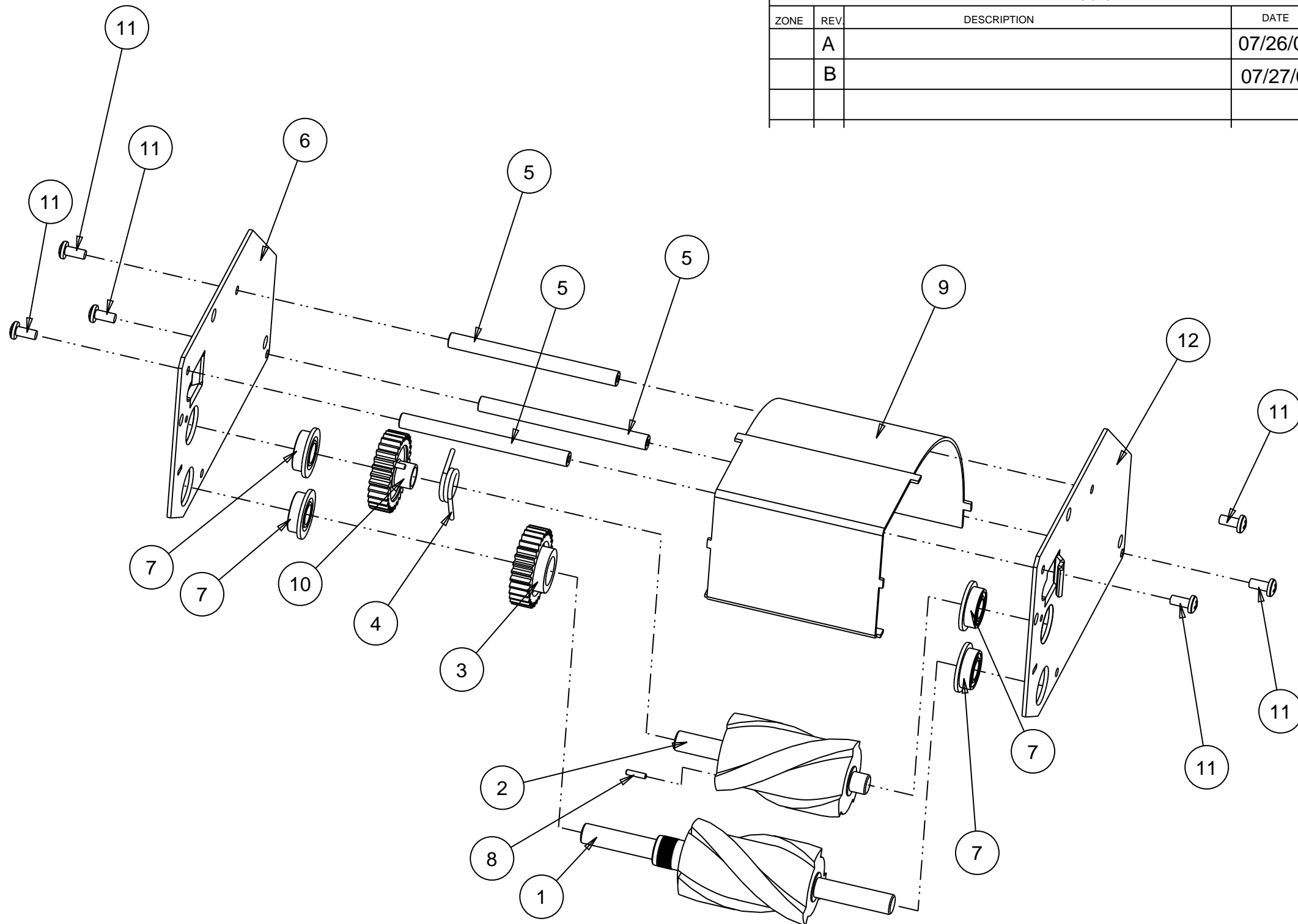

PROPRIETARY AND CONFIDENTIAL THE INFORMATION CONTAINED IN THIS DRAWING IS THE SOLE PROPERTY OF BENCHMARK GAMES. ANY REPRODUCTION IN PART OR AS A WHOLE WITHOUT THE WRITTEN PERMISSION OF BENCHMARK GAMES IS PROHIBITED.	UNLESS OTHERWISE SPECIFIED: DIMENSIONS ARE IN INCHES TOLERANCES: ANGULAR: +/-1 DEG. .XX= +/-0.010" .XXX= +/-0.005 .XXXX= +/-0.003	Benchmark Games	
	DRAWN BY: S. Corso	TITLE: ticket eater belt Cutter Assembly (87-ASM-28)	
MATERIAL	COMMENTS:	SIZE B	DWG. NO. 87-ASM-24
FINISH		SCALE: 1:1.5	WEIGHT: SHEET 6 OF 6

ITEM NO.	Description	Part Number	QTY.
1	idler arm side belt shm	87-SHM-85	1
2	idler arm roller	87-SCM-60	1
3	AFBMA 12.2 - 0.1875 - 0.5000 - 0.1960 - 8,SI,NC,8	BRG-001	2
4	nut fiberlock 1032	N/A	1
5	washer 10IDx375ODx036Thick	N/A	1

REVISIONS			
ZONE	REV	DESCRIPTION	DATE
	A	Release to Production	07/31/07

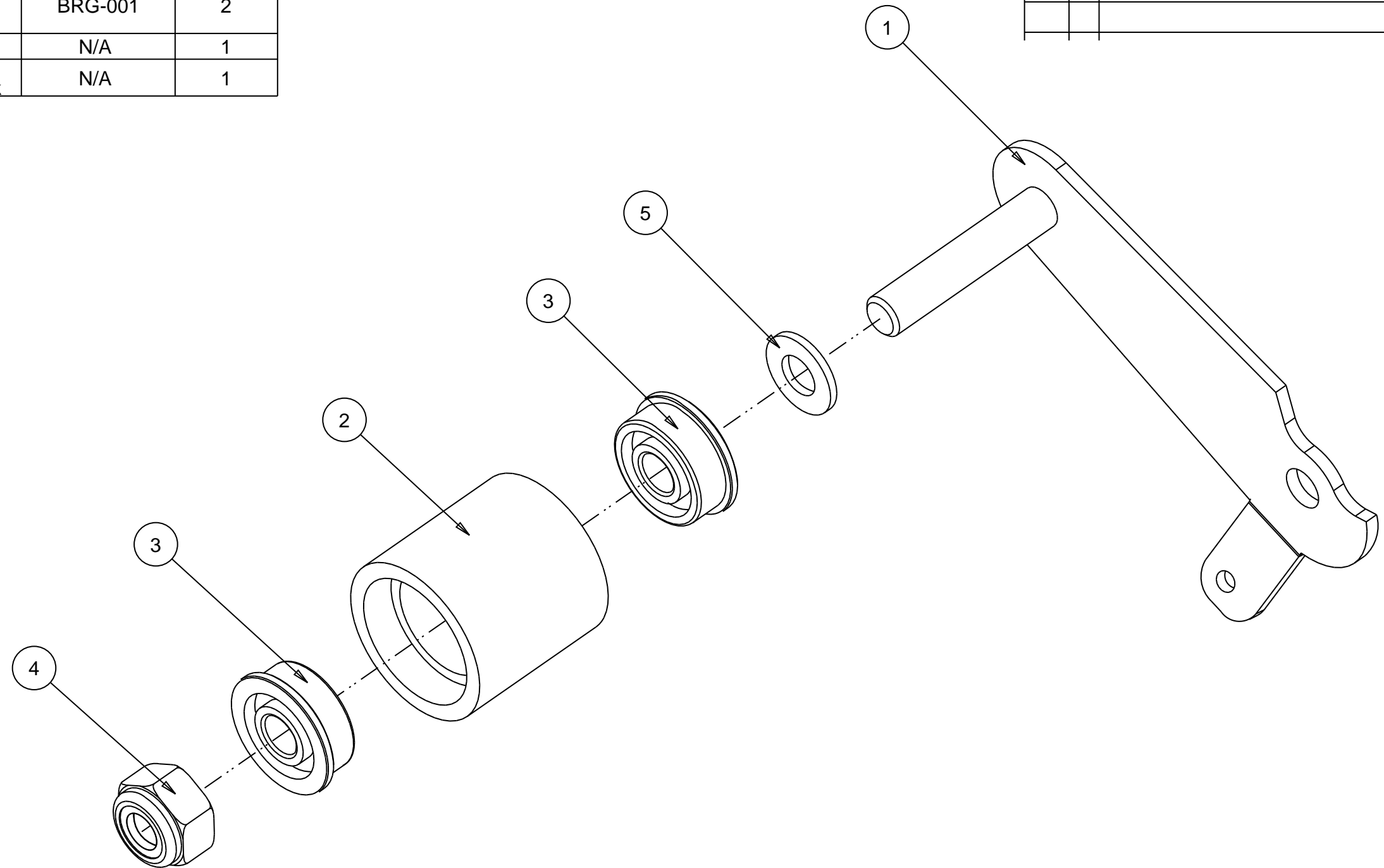

PROPRIETARY AND CONFIDENTIAL THE INFORMATION CONTAINED IN THIS DRAWING IS THE SOLE PROPERTY OF BENCHMARK GAMES. ANY REPRODUCTION IN PART OR AS A WHOLE WITHOUT THE WRITTEN PERMISSION OF BENCHMARK GAMES IS PROHIBITED.	UNLESS OTHERWISE SPECIFIED: DIMENSIONS ARE IN INCHES TOLERANCES: ANGULAR: +/-1 DEG. .XX= +/-0.10" .XXX= +/-0.005 .XXXX= +/-0.003	Benchmark Games	
	DRAWN BY: S. Corso	TITLE: idler arm side belt	
MATERIAL	COMMENTS:	SIZE B	DWG. NO. 87-ASM-49
FINISH		SCALE: 2:1	REV
		WEIGHT:	SHEET 1 OF 1